

**EASY-LASER®**

www.easylaser.com

XT770

Download on the  
App Store

GET IT ON  
Google Play

RUN IT ON  
EASY-LASER **XT11**



Know your machine from every angle.

**Shaft Alignment**

**XT770**



**IP66  
IP67**

# MEASUREMENT INDEPENDENCE

## **EASY-LASER® GENERATION XT**

Easy-Laser® XT770 is the most powerful amongst our Generation XT shaft alignment systems. Built upon our ground-breaking cross-platform technology, it is giving you the freedom to work with the display unit that suits you and the job best. Simply download our straightforward XT application for free and you have all the measurement programs you need.

## **NO LOCK-INS**

With Generation XT you decide if you want the rugged and user-friendly Easy-Laser® XT11 display unit to be included or not. The app also runs on your iOS® or Android® device\*, be it a tablet or a phone, meaning you are never locked in to a specific way of working.

## **NO LICENSE HASSLE**

Your Generation XT measuring units determine what functions are available. No hassle with licenses, just connect the units to the app, on any of your display devices, and start measuring. That is straightforward!

## **MAXIMUM FLEXIBILITY!**

*The XT Alignment app runs on iOS and Android devices\*, as well as on the Easy-Laser® XT11 display unit. The choice is yours.*



*\*Conditions apply*

# HIGHLIGHTS

## MAXIMUM FLEXIBILITY



### ALL XT PROGRAMS IN ONE FREE APP

All XT measurement programs included in one straightforward application available for free.



### DISPLAY DATA ON MULTIPLE PLATFORMS

Functionality for iOS, Android and Easy-Laser® XT display units.



### NO LOCK-INS

Buy with or without the user-friendly Easy-Laser® XT11 display unit.



### MAXIMUM FLEXIBILITY

Combine several measuring units with the display unit of your choice, or use different display units with one set of measuring units. No license hassle!



### RUGGED DESIGN

The XT products are rugged, rated both IP66 and IP67 water and dust proof. For superior durability in harsh environments.



### LONG OPERATING TIMES

The long operating times of up to 16 hours for the display unit and 24 hours for the measuring units mean even the toughest jobs will be finished on time with no interruptions.



### SEND THE REPORTS

Share the reports via email. Possible on all platforms.

(Note: Photo shows XT60 measuring unit.)

# XT770

# THIS IS EASY ALIGNMENT

## HORIZONTAL PROGRAM



The user interface is intuitive and guides you through the measurement process. It is animated and zooms in to the relevant element for each step. You can save the measurements of a machine for *As found* and *As left* in the same file.

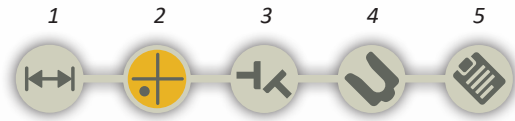

The interactive workflow indicator lets you easily jump to any part in the measurement process.

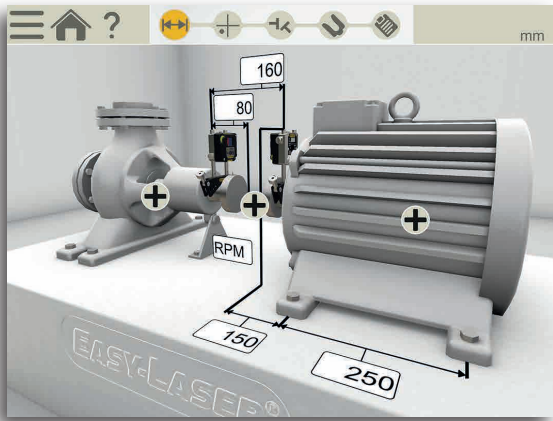

1. Enter dimensions



2. Measure (Four methods available, explained to the right)

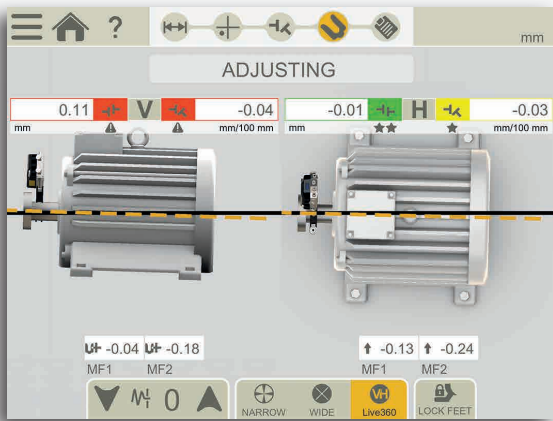

3. View result, *As found*  
4. Adjust

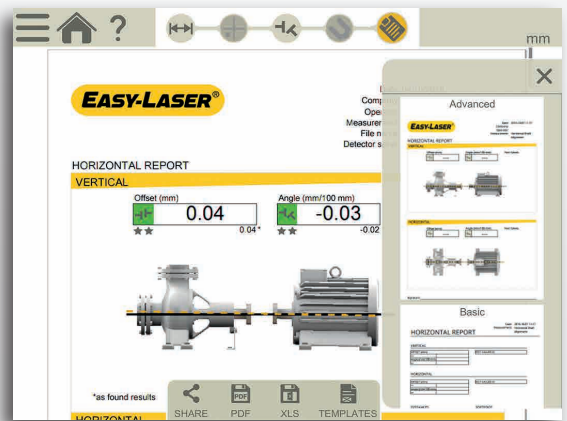

5. View report as it will look

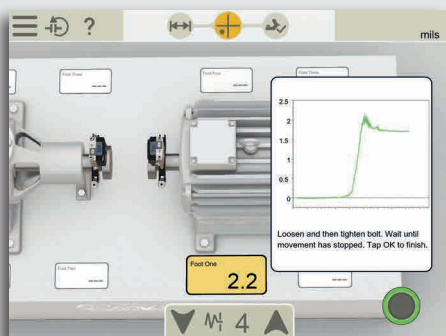

Soft Foot check on both machines.



Tolerance check (pre-set or custom)



Quality check view for measurements

# SMART FUNCTIONS

## MEASUREMENT METHODS

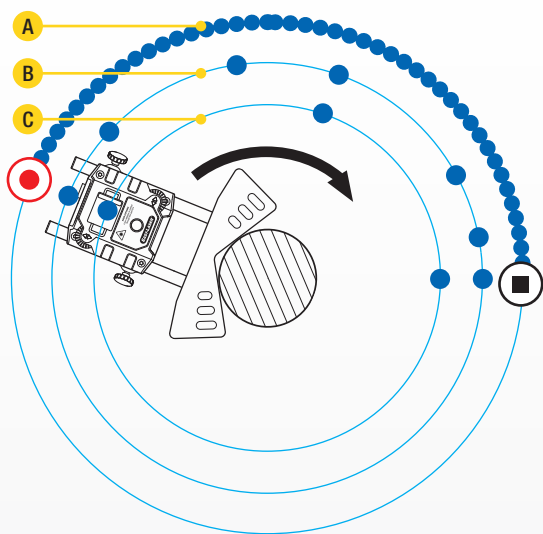

● Measuring points

● Start recording

■ Stop recording



### CONTINUOUS SWEEP (A)

Automatic recording of measurement values during continuous sweeping of the shaft. Hundreds of points are registered. You can start anywhere on the turn. Quality check of measurement is provided (see example down left).



### MULTI POINT (B)

Multi point is basically the same as EasyTurn™, but instead you can record multiple points on the sector rotated. This will provide an optimized calculation basis. Perfect for e.g. turbine and sliding bearing applications.



### EASYTURN (C)

The EasyTurn™ function allows you to begin the measurement process from anywhere on the turn. You can turn the shaft to any three positions with as little as 20° between each position to register the measurement values. An easier-to-use version of the three-point method (see 9–12–3).



### 9–12–3

Measurement points are recorded at fixed points 9, 12 and 3 o'clock. This is the classic three-point method which can be used in most cases.



### THERMAL GROWTH

Automatically compensate for thermal expansion of the machines.



### SWAP VIEW

Understand adjustment directions more intuitively.



### CONTINUE SESSION

Your latest measurement is always available, automatically saved.



### MEASUREMENT VALUE FILTER

Improve readings when measuring conditions are poor.



### MULTIPLE SETS OF FEET

Align machines with more than two pairs of feet.



### LOCKED FEET

Lock any pair of feet on the machine. Used when aligning base-bound or bolt-bound machines.



### WIDE LIVE ADJUSTMENT

Adjust with live values using expanded sensor position ranges in the H and V position

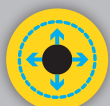

### 360° LIVE ADJUSTMENT

Adjust both vertically and horizontally at the same time with measuring units in any position.



### SELECT COUPLING TYPE

Choose method depending on coupling type: short flex, spacer shaft.



### SELECT MACHINE IMAGE

Choose from different 3D machines to portray your machinery on either side of coupling.



### BUILT-IN HELP

The app includes a searchable *Users Manual* which opens the relevant chapter depending where in the process you are. This makes it quick and easy to find the answer to your user questions.

# XT770

# MORE POSSIBILITIES

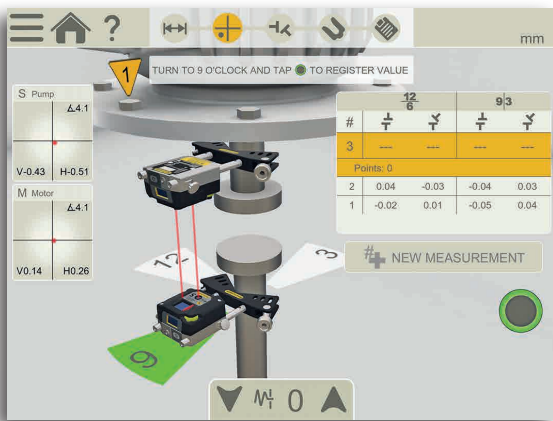

## VERTICAL/FLANGE MOUNTED MACHINES



For measurement and alignment of vertically and flange mounted machines. Handles machines with 4, 6, 8 and 10 bolts.

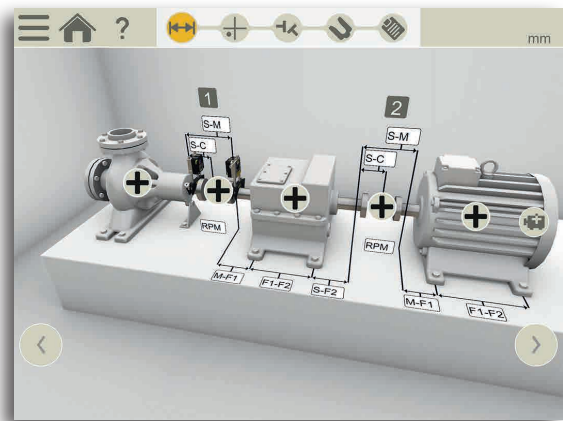

## MACHINE TRAIN



Build your own machine train without limits. You can pick the reference machine manually, or let the program choose one that will minimize the need for adjustments.

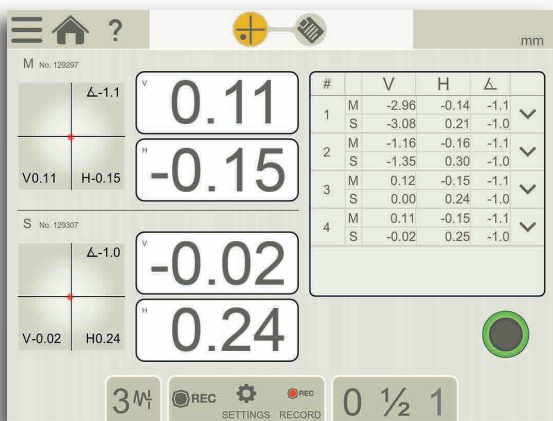

## VALUES – DIGITAL DIAL INDICATOR



With the Values program you measure as with dial gauges, but with laser precision and the possibility to document the measurement result. Automatic recording possible (set the interval and duration). You can make individual notes for each measurement point.

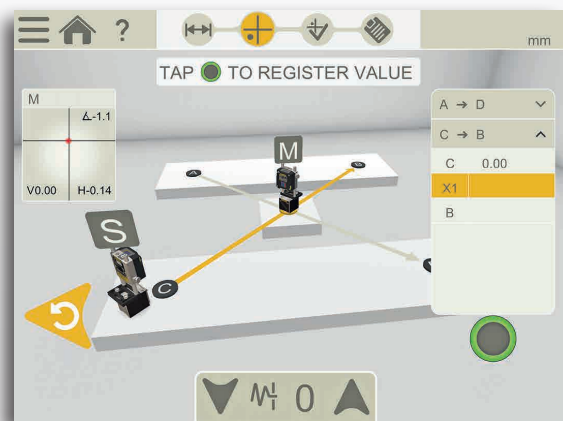

## TWIST MEASUREMENT OF MACHINE BASE



The twist measurement program allows you to check the flatness or twist of the machine foundation using only the measuring units in the system.

## CHECK BEARING CLEARANCE etc.



With the Values program you can check bearing clearance or shaft load. It can also be used to "manually" calculate straightness, flatness and dynamic movements of machine components.

## EASYTREND



With EasyTrend you can keep track of machine movement over time. For example, you can check for thermal expansion and pipe strain issues.

(Requires additional DM-brackets.)

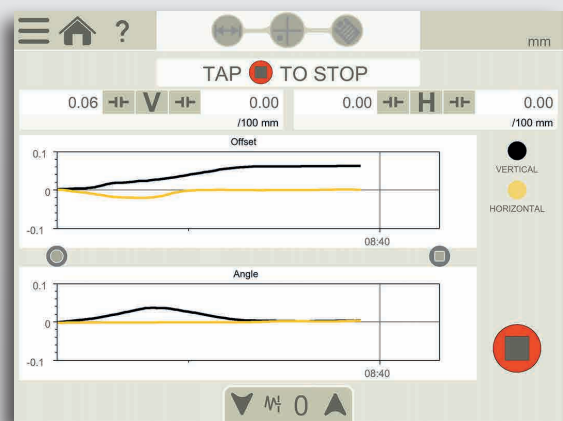

# DOCUMENTATION

## SAVE!



### INTERNAL MEMORY

Save your measurement files, photos and reports to the internal memory.



### VERSATILE FILE TYPES

Both a PDF and an Excel file are generated.

TYPE	NAME	DATE	Edit
[-]	Shaft_2018-02-14 14_21_05	2018-02-14	[Edit]
V.0.00 H.0.00	Values_2018-04-10	2018-04-10	[Edit]
[IMG]	IMG_20180410_142801	2018-04-10	[Edit]
[-]	Shaft Alignment Water pump 3	2018-04-10	[Edit]
[+]	Vertical motor ABB	2018-04-14	[Edit]

## SHOW!



### CUSTOM PDF REPORT TEMPLATES

Use one of the two formats included, or design your own.



### ADD NOTES

Explain it a little more.



### ADD PHOTO

Show what you mean.



### ADD THERMAL IMAGE

See the difference after alignment.  
(Available only with XT11)

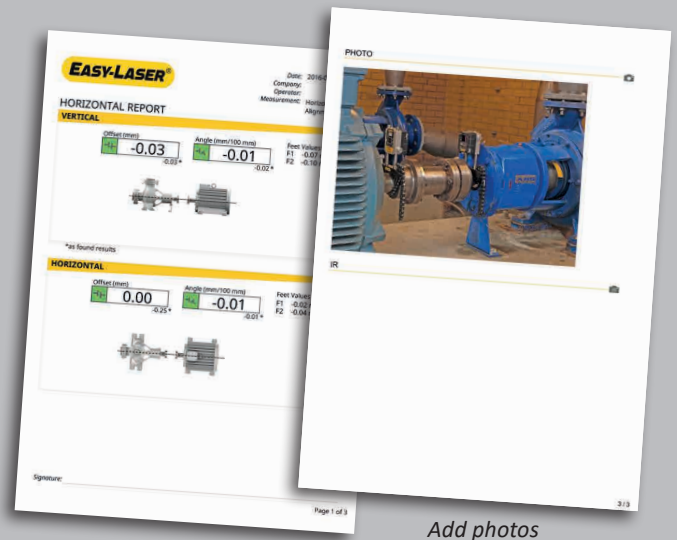

Add photos

## SHARE!



### SEND THE REPORTS

Share the reports via email.  
Possible on all platforms.



### SAVE TO USB

Save your files to USB stick and copy to other devices.



# XT770

# SYSTEM PARTS

## XT70-M/S MEASURING UNITS

The XT70 measuring units utilize dot-type laser and 2 axis square PSD surfaces. A state-of-the-art OLED display (D) shows the angle of the unit, making it easier to position it on the shaft.

The diagonally positioned locking knobs securely lock the unit on the rods. Rigid aluminium housing provide maximum stability. IP66 and 67, dust- water- and shockproof. Heavy-duty battery for very long operating times; up to 24 hours. Built-in wireless technology.

## SHAFT BRACKET

The V-bracket is light yet rigid, with two rods for maximum stability in all directions. Pre-mounted chain for quick setup on the machine.



- A. PSD aperture
- B. Laser aperture
- C. Laser angle adjustment
- D. OLED display: battery status/unit angle
- E. Chain tightening knob
- F. Charger connector
- G. Extendable stainless steel rods
- H. Locking knob
- I. Slidable target/dust cover

## XT11 DISPLAY UNIT

Rugged, robust, with wear resistant rubberized protective coating. IP66 and 67, dust-water- and shockproof. As standard a 13 MP camera for documentation is built-in, and you can also choose to add an IR camera to the XT11; shoot a thermal image before and after alignment and include with the documentation!

A large 8", glove-enabled touch-screen makes the information clear and the app easy to use. The small OLED display (C) shows battery status of both measuring units and display unit. You can check battery status also when the unit is turned off (B). The clever lock-screen button (B) prevents unintentional clicks, for instance when moving around on the job.

Four fastening points for shoulder strap or customized solutions. Heavy-duty battery for very long operating times; up to 16 hours. The camera can be removed if security reasons require it.



- A. Ergonomically, rubber coated housing
- B. Screen-lock button/Battery status-check button
- C. OLED display
- D. Display brightness sensor
- E. Large and clear 8" glove-enabled touch-screen
- F. Dust cover and protection for connectors (Note: connectors are dust and waterproof)
- G. Enter button



# RUGGED DESIGN

## DOT-TYPE LASER TECHNOLOGY



The dot laser technology makes it possible to measure larger machines and longer spans than line laser systems. It also provides higher accuracy when backlash in the coupling is present. In addition, dot laser allows you to check more things when installing a machine, e.g. twist of foundation and bearing clearance. With 2 axis PSD you can read off and record values for both vertical and horizontal directions.

## DUAL LASERS, PSD, INCLINOMETERS

With electronic inclinometers in both measuring units the system knows exactly how they are positioned. This also makes it very easy to align uncoupled shafts. The so called reversed measurement method with two laser beams and two PSD makes it possible to also measure grossly misaligned machines. This is particularly good for new installations, where the machines are not yet in the correct position. With the Dual Technology, measurement accuracy is retained even over longer distances.



## IP66 AND IP67 APPROVED

Easy-Laser® XT measuring units and display unit are waterproof, dustproof and shockproof. The units have been tested and approved to an Ingress Protection rating of IP66 and IP67, which means that they are dustproof and waterproof to a depth of 1 metre, and also protected against powerful water jets.

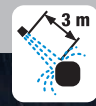

(Note: Photo shows XT40 measuring units.)

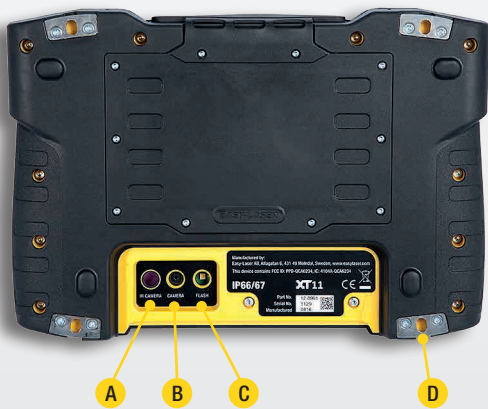

- A. IR Camera (optional)
- B. 13 Mp Camera
- C. LED Light
- D. Fastening points for shoulder strap (x4)



## THERMAL CAMERA

The Easy-Laser® XT11 Display unit has the option to add thermal imaging camera (IR) along with the standard 13 MP digital camera. Shoot a thermal image before and after alignment and include with the documentation!



## 13 MP CAMERA

Take pictures to identify your machines and include with your report.



## LED LIGHT

Light up the work area when ambient light is not enough.

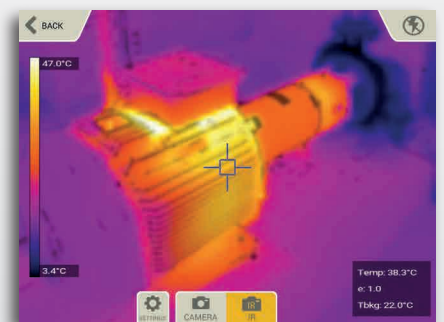

## AV CONNECTOR

As standard the XT11 is equipped with a HDMI connector, making it possible to share the display screen direct on a TV monitor or projector screen without any additional software. Useful for training purposes with large groups.



- E. Charger
- F. USB A
- G. AV connector (HDMI)
- H. USB B

# XT770

# SHAFT BRACKETS

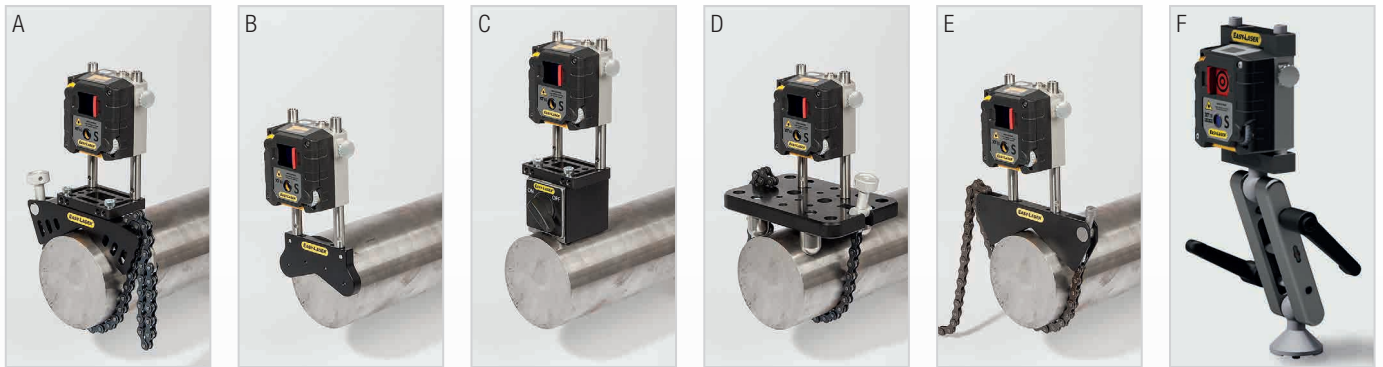

A. Offset bracket, 2 pcs included

B. Magnetic bracket\*

C. Magnet base, 2 pcs included

D. Sliding bracket, Part No. 12-1010\*

E. Thin shaft bracket, Width 12 mm [0.5"], Part No. 12-1012\*

F. DM-bracket. For dynamic measurements.

Complete kit with 2 brackets, Part No.12-1130\*

G. Extension rods (not pictured):

Length 30 mm [1.18"], (x1) Part No. 01-0938

Length 60 mm [2.36"], (x4) Part No. 12-0059

Length 120 mm [4.72"], (x8) Part No. 12-0324

Length 240 mm [9.44"], (x4) Part No. 12-0060

\*Accessories

# BELT ALIGNMENT TOOL

## FOR RADIALLY MOUNTED DRIVES



With the Belt alignment tool XT190

BTA you can align most types of radially

mounted drives. The transmitter and detector

attaches magnetically to the sheave

edge. A digital display unit gives the advantage of checking against belt manufacturer tolerances.

When connected to the XT Alignment App on your iOS or Android device, or the XT11, you can also read off the alignment "live" at the position on the machine where the actual alignment is made. You get adjustment values for both horizontal and vertical direction (shim value), resulting in a more accurate alignment in a shorter time.

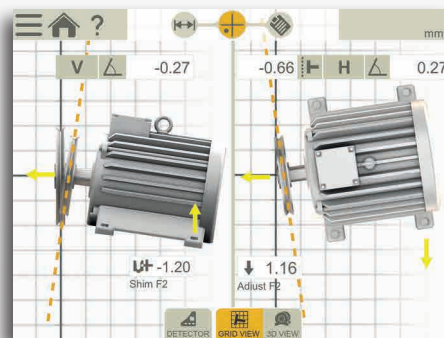

**0.6 mm**  
**0.35 °H**  
**0.45 °V**

OLED display on detector unit. Live values.

Align machine in live mode, document result with PDF. (XT Alignment app Belt application.)

**SYSTEM XT190 BTA**  
**PART NO. 12-1053**



# VIBROMETER TOOL

## FOR QUICK VIBRATION ANALYSIS



Easy-to-use vibration analyser that quickly diagnose vibration level, unbalance, misalignment and looseness. The direct readout of 1x, 2x, 3x RPM, total level as well as bearing condition provide necessary information during installation and alignment.

The XT280 connects to the XT Alignment App, making it possible to document the result as PDF.

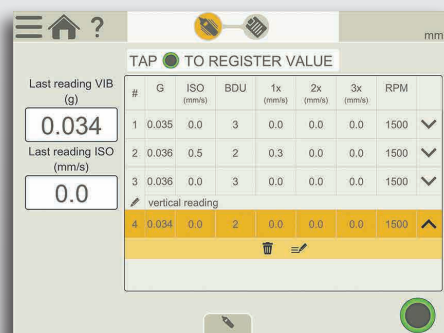

**7.5** ISO mm/s  
**23** BDU  
**0.4** g

Display on vibrometer unit. Live values.

Register values with notes for each point, add photo of machine, document result with PDF.

**SYSTEM XT280 VIB PART NO. 12-1090**



# SYSTEMS



- A. Offset brackets
- B. Magnetic brackets\*
- C. Magnet bases
- D. XT280 VIB\*
- E. XT190 BTA\*

\*Accessories, not included as standard.

## PART NO. 12-1095

### Display unit, Large case.

Weight: 11.9 kg [26.2 lbs]  
Dimension WxHxD: 565x455x210 mm [22.2x17.9x8.2"]

## PART NO. 12-1096

### Same as above, but without display unit.

Weight: 10.4 kg [22.9 lbs]

## PART NO. 12-1127

### Display unit, GEO Kit, Large case GEO.

14.7 kg [32.4 lbs]  
Dimension WxHxD: 565x455x210 mm [22.2x17.9x8.2"]

## PART NO. 12-1128

### Same as above, but without display unit.

13.2 kg [29.1 lbs]

# GEO KIT

## GEOMETRIC MEASUREMENTS KIT

**GEO** With this kit added to your XT770, using the Values program, you will be able to take flatness and straightness measurements with the highest reliability and precision.

The kit includes the very versatile and long proven laser transmitter D22 (pictured) plus geo brackets.



# TECHNICAL DATA

## Measuring units XT70-M / XT70-S

Type of detector	2 axis TruePSD 20x20 mm [0.79x0.79"]
Communication	BT wireless technology
Battery type	Heavy duty Li Ion chargeable
Operating time	Up to 24 h continuously
Resolution	0.001 mm [0.05 mils]
Measuring errors	<1%
Measurement range	Up to 20 m [66 feet]
Type of laser	Diode laser
Laser wavelength	635-670 nm
Laser class	Safety class 2
Laser output	<1 mW
Electronic inclinometer	0.1° resolution
Environmental protection	IP class 66 and 67
Operating temperature	-10-50 °C
Storage temperature	-20-50 °C
Relative humidity	10-95%
OLED display	128x64 pixels
Housing material	Anodized aluminium + PC/ABS + TPE
Dimensions	WxHxD: 76x76.7x45.9 mm [3.0x3.0x1.8"]
Weight	272 g [9.6 oz]

## Display unit XT11

Type of display/size	SVGA 8" colour screen, backlit LED, multitouch
Battery type	Heavy duty Li Ion chargeable
Operating time	Up to 16 h continuously
Connections	USB A, USB B, Charger, AV
Communication	Wireless technology, WiFi
Camera, with diode lamp	13 Mp
IR camera (optional)	FLIR LEPTON® (0-450 °C, 32-842 °F)
Languages	en / de / sv / es / pt / ru / ja / ko / zh / it / fr / pl
Help functions	Built-in manual
Environmental protection	IP class 66 and 67
Operating temperature	-10-50 °C
Storage temperature	-20-50 °C
Relative humidity	10-95%
OLED display	96x96 pixels
Housing material	PC/ABS + TPE
Dimensions	WxHxD: 274x190x44 mm [10.8x7.5x1.7"]
Weight	1450 g [51.1 oz]

## Cable

Charging cable (splitter cable)	Length 1 m [39.4"]
---------------------------------	--------------------

## Brackets etc.

Shaft brackets	Type: V-bracket for chain, width 18 mm [0.7"] Shaft diameters: 20-150 mm [0.8-6.0"] With extension chain, diameters up to 450 mm [17.7"] Material: anodised aluminium
Rods	Length: 120 mm, 60 mm [4.72", 2.36"] (extendable) Material: Stainless steel

## All Easy-Laser® XT770 Shaft systems include:

- 1 Measuring unit XT70-M
- 1 Measuring unit XT70-S
- 2 Shaft brackets with chains and rods 120 mm [4.72"]
- 4 Rods 60 mm [2.36"]
- 4 Rods 120 mm [4.72"]
- 2 Magnet bases
- 2 Offset brackets
- 2 Extension chain 900 mm [35.4"]
- 1 Measuring tape 3 m [9.8"]
- 1 Hexagon wrench set
- 1 Charger (100-240 V AC)
- 1 DC split cable for charging
- 1 DC to USB adapter, for charging
- 1 Quick reference manual
- 1 Cleaning cloth for optics
- 1 USB memory with manuals
- 1 Documentation folder
- 1 Carrying case Large (or Large Geo)

## Part No. 12-1095 and 12-1127, also include:

- 1 Display unit XT11
- 1 Shoulder strap for display unit

## Part No. 12-1127 and 12-1128 also include:

- 1 Laser transmitter D22
- 1 Magnet base with turnable head (replaces one of the regular magnet bases)
- 4 Rods 120 mm [4.72"]

## Customize your XT11 (Note that these options cannot be retrofitted):

- Part No. 12-0968 IR Camera added to XT11
- Part No. 12-0985 Camera (and LED light) removed from XT11

# EASY-LASER® GENERATION XT

*The age of measurement independence is here!*



**Android**

**iOS**

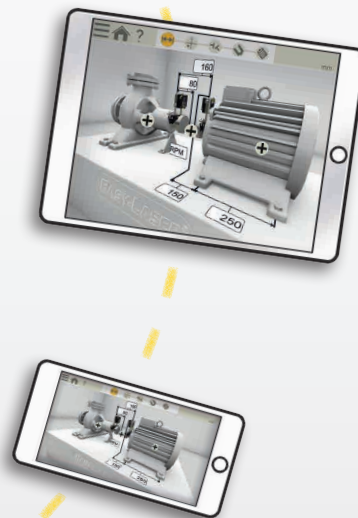

**NO LOCK-INS**

With Generation XT you decide if you want the rugged and user-friendly Easy-Laser® XT11 display unit to be included or not. The app also runs on your iOS or Android device\*, be it a tablet or a phone, meaning you are never locked in to a specific way of working.

**SAME INTERFACE**

Purchase multiple systems with various capabilities, train once! The training costs are minimized significantly since the app interface and basic functionality is identical for all systems.

*\*Conditions apply*

Easy-Laser® is manufactured by Easy-Laser AB, Alfagatan 6, SE-431 49 Mölndal, Sweden  
 Tel +46 31 708 63 00, Fax +46 31 708 63 50, e-mail: info@easylaser.com, www.easylaser.com  
 © 2018 Easy-Laser AB. We reserve the right to make changes without prior notification.

Easy-Laser® is a registered trademark of Easy-Laser AB. Android, Google Play, and the Google Play logo are trademarks of Google Inc. Apple, the Apple logo, iPhone, and iPod touch are trademarks of Apple Inc., registered in the U.S. and other countries. App Store is a service mark of Apple Inc. Other trademarks belong to their respective owners. This product complies with: EN60825-1, 21 CFR 1040.10 and 1040.11. Contains FCC ID: Q0QBGM111, IC: 5123A-BGM111 and FCC ID: 2AFDI-ITCNFA324 IC: 9049A-ITCNFA324. Documentation ID: 05-0914 Rev1

